

# Series 255 Valve / 960 Control

---

Water Conditioning Control System  
Operation and Maintenance Manual

---

---

## Table of Contents

Introduction . . . . .	3
Special Features . . . . .	3
General Conditioner Information . . . . .	3
How Your Conditioner Works	
Model 960 Control Front Panel	
Control Settings . . . . .	4
General Information	
Time Of Day Clock	
Time of Regeneration	
Hardness Setting	
Salt Setting	
Capacity Setting	
Water Conditioner Regeneration . . . . .	7
Automatic Regeneration	
Manual Regeneration	
Care of Your Water Conditioner . . . . .	7
General	
Cleaning the Injector/Injector Screen	
Maintaining the Drain Line	
Manual Valve Operation . . . . .	9
Additional Features . . . . .	9
Disinfection of Water Conditioners . . . . .	9
Replacement Parts . . . . .	10
Troubleshooting . . . . .	14
Alarms	
Troubleshooting Procedures	
Specifications . . . . .	17
Glossary of Terms . . . . .	17

## Safety

**Important:** The plug-in transformer for this equipment is rated for indoor use only.

**Important:** Never attempt to work on this control while standing in or near water without disconnecting electrical power to the control.

## Introduction

The Model 960 control provides sophisticated, demand-based water conditioning by incorporating a microprocessor and a water meter to electronically monitor the amount of water used daily. Each day, at Time of Regeneration, the control determines if the capacity remaining is sufficient to provide conditioned water for the next day. If the remaining capacity is too small, the control automatically regenerates the resin bed.

If water usage changes, the computer automatically compensates for the change and regenerates as needed. Regeneration is based on actual water usage. The control provides efficient, trouble-free, uninterrupted soft water luxury.

The Series 255 valve combines design simplicity with glass reinforced Noryl\* plastic construction to provide an uncommonly reliable appliance.

If maintenance becomes necessary, the Model 960 Series 255 water conditioning system offers a unique "separation" capability for quick repairs.

\*Noryl is a trademark of General Electric Company.

## Special Features

- **Memory Retention.** During a power outage, critical operating information in the control's memory is stored in a special electronic device called a NOVRAM. This information includes the time of day, water usage amounts, daily average water usage, all programming data and the number of days since the last regeneration. When power is restored, the information is returned to the microprocessor and operation resumes as if an outage never occurred. The time of day will be late by the length of the power outage. Because most power outages are less than one minute in duration, it may be months or years before the time display requires resetting. If an outage of one or more hours occurs, the time of day should be reset but no other reprogramming is necessary.
- **Design Reliability.** Solid-state electronics assure many years of trouble-free performance. The metering system has only one moving part – a rotating turbine that measures water usage.
- **Time and Capacity Display.** During normal conditioning operation, the correct time of day alternates with capacity on the display. The capacity value is the number of gallons (cubic meters for metric units) of water that the unit can condition before another regeneration is needed.
- **Flow Indicator.** The colon between the hours and minutes in the Time of Day display flashes to indicate the flow of service water through the valve. This provides an easy determination of proper meter operation.

- **Hardness and Capacity Settings.** Once the hardness and capacity settings are entered, the information cannot be lost due to a power outage, so reprogramming is not necessary.
- **Guest Cycle.** An extra regeneration can be achieved at any time by pressing the REGEN button on the front panel. It takes a few minutes for the regeneration to start. The unit completes the regeneration in about two hours. This feature is beneficial when you expect to use more than the normal amount of water; for example, guest visits or an extra heavy laundry day.

## General Conditioner Information

### How Your Conditioner Works

In general, your water conditioner works in the following manner. Hard water flows into the conditioner and through the resin bed where calcium and magnesium hardness minerals are exchanged. The conditioned water flows out of the resin bed into your plumbing system. After a certain amount of hard water has passed through the conditioner, the resin cannot remove any more minerals. This resin state is called exhaustion and indicates that the resin needs to be regenerated. The regeneration process restores the conditioner's ability to soften water. The control monitors the amount of water that flows through the conditioner and automatically calculates when to regenerate the resin bed.

### Model 960 Control Front Panel

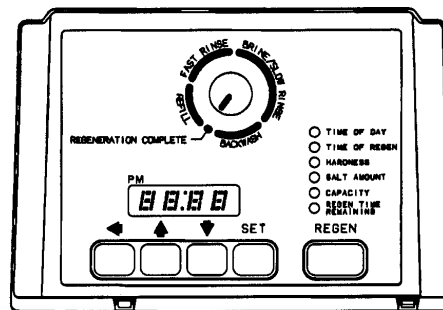

Figure 1

The main components of the Model 960 control front panel are:

- Regeneration Cycle Indicator
- Green Indicator Lights
- Four-Digit Display
- Programming Push Buttons
- REGEN Push Button

Refer to Figure 1 or your conditioner for the location of these features.

---

---

The front panel incorporates several important features which allow you to know the status of your water conditioner. These features are:

- **Regeneration Cycle Indicator.** The white indicator points to the status of the conditioner. Soft water is available when the indicator points to REGENERATION COMPLETE. Other positions indicate that the conditioner is regenerating the resin bed and only hard water is available.
- **Four-Digit Display.** The four-digit red LED display shows system information such as time of day, gallons of conditioned water available, time the conditioner will regenerate, or any error alarms.
- **Green Indicator Lights.** The green indicator lights are located at the right of the control panel.
  - TIME OF DAY
  - TIME OF REGEN
  - HARDNESS
  - SALT AMOUNT
  - CAPACITY
  - REGEN TIME REMAINING

When a green light is on next to one of the six control legends, the LED display provides information pertaining to that legend. When conditioned water is available, the display alternates between TIME OF DAY and CAPACITY and the corresponding green lights alternate between these control legends.

- **Programming Push Buttons.** The programming buttons are located at the bottom of the panel under the display. Use the buttons to look at or change the conditioner settings.
- **REGEN Push Button.** The REGEN button is located at the bottom of the panel below the six indicator lights. Press the button to start a regeneration of the water conditioner.

**Note:** If you press the button again a minute or more after regeneration begins, a second regeneration will start when the first regeneration is complete. The display freezes with the REGEN TIME REMAINING information. After the first regeneration is complete, the second regeneration begins immediately. The display will alternate between the TIME OF DAY and REGEN TIME REMAINING.

## Control Settings

### General Information

Use the four programming push buttons to change any of the control settings. Settings can only be changed if the regeneration cycle indicator is pointing at REGENERATION COMPLETE. If you try to change a setting when the cycle indicator is in any other position or if the setting is not valid, the control beeps to let you know that the new setting has been ignored.

**To change a setting:** Press the down arrow [↓] button until the green light is illuminated next to the control setting you want to change. That control setting value shows on the display. Press the **SET** button and the far right number on the display starts flashing. If you want to change the number, press the up arrow [↑] button to increase the number or the down arrow [↓] button to decrease the number. To skip the number without changing, press the left arrow [←] button.

**Note:** If you press and hold either the up arrow [↑] button or the down arrow [↓] button for more than one second, the flashing number will scroll up or down.

When the number is correct, press the left arrow [←] button. The first number stops flashing and the next number starts flashing. You can only change the flashing number. Continue changing numbers until you reach the desired setting. Press the **SET** button. The numbers stop flashing and the control accepts the new setting. After approximately 30 seconds, the control starts alternating the display between TIME OF DAY and CAPACITY.

**Note:** If a beep sounds, the new setting is not accepted because it was outside the range of allowable values. The old setting will be shown on the display.

### Time of Day Clock

The control uses the Time of Day clock and the amount of conditioned water remaining to decide when to begin a regeneration. When a regeneration is necessary and the Time of Day clock is at the same time as the Time of Regeneration setting, the control starts the regeneration.

When the green light is on next to the TIME OF DAY legend, the display is showing the time that the control thinks is correct. If you need to change the Time of Day, refer to the instructions later in this section. The Time of Day displays time in hours and minutes separated by a colon[:]. When the colon is flashing on and off, water is flowing through the conditioner. There is a small red dot in the upper left corner near the p.m. letters to indicate p.m. for 12-hour clocks. When the dot is off, the time is a.m. You can set the clock for any time, a.m. or p.m.

Complete the following steps to change the Time of Day:

1. Press the down arrow [↓] button until the green light next to the TIME OF DAY legend is on.
2. Press the **SET** button and the minute number on the display starts flashing. If you want to change this number, press the up arrow [↑] button to increase the number or the down arrow [↓] button to decrease the number. To skip the number without changing, press the left arrow [←] button.
3. When the number is correct, press the left arrow [←] button. The first number stops flashing and the

---

---

next number starts flashing. You can only change the flashing number.

4. Continue changing numbers until you reach the desired setting.
5. Press the **SET** button. The number stops flashing and the control accepts the new setting. After approximately 30 seconds, the control starts alternating the display between TIME OF DAY and CAPACITY.

**Note:** If a beep sounds, the new setting is not accepted.

**Reminder:** The control does not keep time during a power outage but will resume its time, keeping from the time of day power was lost. A short power outage should not cause a problem. If the outage is several hours, the control will regenerate at the wrong time of day. All other memory is stored in the NOVRAM and maintained during power outage. Refer to page 3.

## Time of Regeneration

The control uses the Time of Regeneration to decide when to begin a regeneration. When a regeneration is necessary and the Time of Day clock is at the same time as the Time of Regeneration setting, the control starts regeneration. The factory setting for Time of Regeneration is 2:00 a.m. If this time is inconvenient, you can select any other time of day. Remember that soft water is not available during a regeneration of the water conditioner. Time of Regeneration can be set for any time, a.m. or p.m.

**Note:** The control may be programmed for an immediate regeneration option. In this case, the control does not wait for the Time of Regeneration but regenerates when the remaining capacity reaches zero. Contact your dealer for more information regarding this option.

Complete the following steps to change the Time of Regeneration:

1. Press the down arrow [↓] button until the green light next to the TIME OF REGEN legend is on.
2. Press the **SET** button and the minute number on the display starts flashing. If you want to change this number, press the up arrow [↑] button to increase the number or the down arrow [↓] button to decrease the number. To skip the number without changing, press the left arrow [←] button.
3. When the number is correct, press the left arrow [←] button. The first number stops flashing and the next number starts flashing. You can only change the flashing number.
4. Continue changing numbers until you reach the desired setting.

5. Press the **SET** button. The number stops flashing and the control accepts the new setting. After approximately 30 seconds, the control starts alternating the display between TIME OF DAY and CAPACITY.

**Note:** If a beep sounds, the new setting is not accepted.

## Hardness Setting

The Hardness Setting refers to the amount of hardness minerals in your water before it is conditioned. The control uses this setting to calculate how many gallons of water can be conditioned before a regeneration is necessary.

Your water treatment dealer tested the water at the time of installation and entered a Hardness Setting in the control. We recommend that you consult your dealer or have your water retested before changing this setting.

You can see the Hardness Setting the dealer entered by pressing the down arrow [↓] button until the green light next to the HARDNESS legend is on. The number on the display is the measure of water hardness in grains per gallon (milligrams per liter for metric).

Complete the following steps to change the Hardness Setting:

1. Press the down arrow [↓] button until the green light next to the HARDNESS legend is on. The setting range is 3 to 250 grains/gallon (30 to 2500 milligrams/liter for metric).
2. Press the **SET** button and the first number starts flashing. If you want to change this number, press the up arrow [↑] button to increase the number or the down arrow [↓] button to decrease the number. To skip the number without changing, press the left arrow [←] button.
3. When the number is correct, press the left arrow [←] button. The first number stops flashing and the next number starts flashing. You can only change the flashing number.
4. Continue changing numbers until you reach the desired setting.
5. Press the **SET** button. The number stops flashing and the control accepts the new setting. After approximately 30 seconds, the control starts alternating the display between TIME OF DAY and CAPACITY.

**Note:** If a beep sounds, the new setting is not accepted.

**Reminder:** Whenever the HARDNESS or CAPACITY setting is changed, you should regenerate the conditioner by pressing the REGEN button.

## Salt Setting

The Salt Setting refers to the total amount of salt, in pounds, that the control uses during a regeneration of the resin bed. The amount of salt used in a regeneration determines the amount of water that the conditioner softens between regenerations. If this setting is changed, it may be necessary to change the Capacity Setting as well. Refer to Table 1 for SALT and CAPACITY information.

Complete the following steps to change the Salt Setting:

1. Press the down arrow [↓] button until the green light next to the SALT legend is on. The display shows a number with a zero or a five to the right of the decimal point, no other number can be entered in this position. The setting range is 0.5 to 99.5 pounds (0.1 to 25.5 kilograms for metric).
2. Press the **SET** button and the first number starts flashing. If you want to change this number, press the up arrow [↑] button to increase the number or the down arrow [↓] button to decrease the number. To skip the number without changing, press the left arrow [←] button.
3. When the number is correct, press the left arrow [←] button. The first number stops flashing and the

next number starts flashing. You can only change the flashing number.

4. Continue changing numbers until you reach the desired setting.
5. Press the **SET** button. The number stops flashing and the control accepts the new setting. After approximately 30 seconds, the control starts alternating the display between TIME OF DAY and CAPACITY.

**Note:** If a beep sounds, the new setting is not accepted.

If the control does not display this setting, your dealer has disabled it. Some municipalities require that the Salt Setting not be adjustable. Contact your dealer for additional information.

## Capacity Setting

The Capacity Setting refers to the kilograins of hardness that can be removed by the conditioner between regenerations. Your dealer entered this setting when the control was installed. Please consult with your dealer before changing this setting.

**Table 1 – Suggested Salt Settings (Pounds of Salt for Various Size Conditioners)**

Kilograins of Hardness Capacity Setting	0.5 ft <sup>3</sup>	0.75 ft <sup>3</sup>	1.0 ft <sup>3</sup>	1.25 ft <sup>3</sup>	1.5 ft <sup>3</sup>	1.75 ft <sup>3</sup>	2.0 ft <sup>3</sup>	*2.5 ft <sup>3</sup>	*3.0 ft <sup>3</sup>	*3.5 ft <sup>3</sup>
12	4.5	-	-	-	-	-	-	-	-	-
16	9.0	5.0	-	-	-	-	-	-	-	-
20	-	8.5	6.0	-	-	-	-	-	-	-
24	-	14.0	8.5	7.0	-	-	-	-	-	-
30	-	-	15.0	11.0	10.0	-	-	-	-	-
32	-	-	18.5	13.0	11.0	9.0	-	-	-	-
35	-	-	-	17.0	13.0	11.0	10.0	-	-	-
40	-	-	-	23.0	18.0	14.0	13.0	-	-	-
48	-	-	-	-	28.0	22.0	18.0	14.0	-	-
60	-	-	-	-	-	-	30.0	23.0	18.0	-
72	-	-	-	-	-	-	-	35.0	26.0	23.0
78	-	-	-	-	-	-	-	-	30.0	28.0
81	-	-	-	-	-	-	-	-	36.0	30.0
90	-	-	-	-	-	-	-	-	45.0	38.0
95	-	-	-	-	-	-	-	-	-	42.0
105	-	-	-	-	-	-	-	-	-	56.0

\*Consult factory for specific settings information.

---

---

Complete the following steps to change the Capacity Setting; refer to Table 1:

1. Press the down arrow [↓] button until the green light next to the CAPACITY legend is on. The setting range is 0.1 to 140.0 kilograins (0.1 to 14.00 kilograms for metric).
2. Press the **SET** button and the first number starts flashing. If you want to change this number, press the up arrow [↑] button to increase the number or the down arrow [↓] button to decrease the number. To skip the number without changing, press the left arrow [←] button.
3. When the number is correct, press the left arrow [←] button. The first number stops flashing and the next number starts flashing. You can only change the flashing number.
4. Continue changing numbers until you reach the desired setting.
5. Press the **SET** button. The number stops flashing and the control accepts the new setting. After approximately 30 seconds, the control starts alternating the display between TIME OF DAY and CAPACITY.

**Note:** If a beep sounds, the new setting is not accepted.

**Reminder:** Whenever the HARDNESS or CAPACITY setting is changed, you should regenerate the conditioner by pressing the REGEN button.

If the control does not display the Capacity Setting, your dealer has disabled it. Some municipalities require that the Salt Setting be disabled, which also disables the Capacity Setting. Contact your dealer for additional information.

## Water Conditioner Regeneration

Your water conditioner regenerates for one of two reasons:

- The control determines that the conditioner does not have enough capacity remaining to satisfy your soft water needs for the next day.
- The REGEN button was pressed.

In either case, the REGENERATION INDICATOR makes one complete counterclockwise rotation and returns to REGENERATION COMPLETE. The indicator pauses at some or all of the different positions shown on the label around the indicator. The display alternates between TIME OF DAY and REGEN TIME REMAINING, as indicated by the green lights next to the legends. Regen Time Remaining is shown in minutes on the display. When the indicator reaches REGENERATION COMPLETE and the time remaining is zero, the regeneration is complete, conditioned water is

available for use, and the control starts alternating the display between TIME OF DAY and CAPACITY. **No settings can be changed during a regeneration.** The settings can be viewed, but the control beeps and ignores any attempt to change settings.

## Automatic Regeneration

The control makes regeneration decisions based on the amount of water that has flowed through the conditioner. The control uses the Hardness and Capacity settings to calculate the number of gallons (cubic meters for metric) which can be conditioned. At the Time of Regeneration, the control updates the average usage for the previous day and adjusts the reserve capacity accordingly. The reserve is kept at a minimum for optimum economy. The control reacts to a sudden increase in water usage. If a day's usage is more than double the current average, the control anticipates that a second day of high usage is likely to occur. The high usage amount is used as the reserve when the control performs the regeneration computation.

The Guest Cycle option and the Calendar Override option may override this computation. Refer to the **Additional Features** section in this manual or contact your dealer for more information about these options. The factory setting for Time of Regeneration is 2:00 a.m. You can change this time. Refer to the **Time of Regeneration** section in this manual for additional information.

## Manual Regeneration

To force the control to perform a regeneration, press the REGEN push button. This button is located on the front of the control. When you press the REGEN button, the control performs a full regeneration of the conditioner. You can use this feature if you need a large amount of conditioned water but the capacity remaining is low.

**Note:** If you press this button again a minute or more after regeneration begins, a second regeneration will start when the first regeneration is complete. The display shows only the REGEN TIME REMAINING information.

## Care of Your Water Conditioner

### General

Check the salt level in the salt storage tank a few weeks after installation and weekly after that. Always maintain the salt level above the water level for a consistent salt dosage and proper water conditioner operation. Don't allow the conditioner to run out of salt before refilling. When filled, the salt storage tank contains enough salt to support numerous resin bed regenerations. Use pellet, block, or nugget water conditioner salt. Do not

pellet, block, or nugget water conditioner salt. Do not use rock salt. Some rock salt may contain high levels of impurities which affect conditioner operation. Have the salt storage tank serviced once a year to remove accumulated sediment that may impede brine draw.

### Cleaning the Injector/Injector Screen

The injector is the component which creates the vacuum necessary to draw the brine into the water conditioner. Clean the injector and injector screen once a year in order to maintain proper water conditioning. Some locations may require more frequent injector and screen servicing.

Complete the following steps to clean the injector screen and injector:

1. Unplug the wall-mount transformer.
2. Shut off the water supply or put the bypass valve(s) into the bypass position.
3. Remove the rear cover by pushing back on the tab provided on the cover. Next, lift the rear cover off the valve, Figure 2.

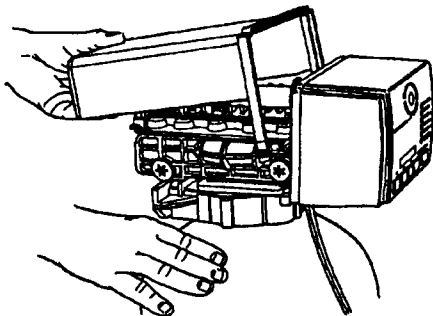

Figure 2

4. Relieve system pressure by opening the Fast Rinse Drain Valve (the fifth valve back from the control) with a screwdriver, Figure 3.

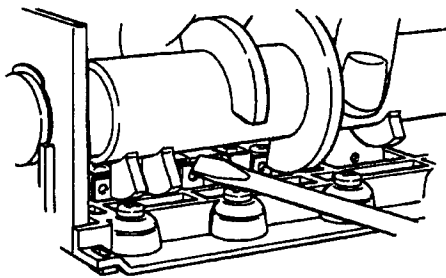

Figure 3

5. Using a screwdriver, unscrew and remove the injector screen and the injector cap, Figure 4.

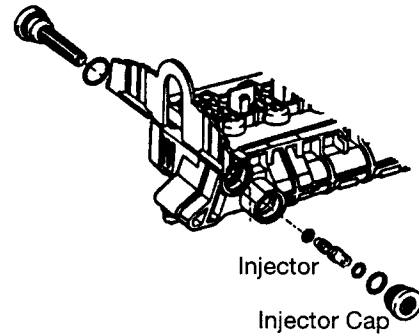

Figure 4

6. Clean the screen with a fine brush. Flush with water until clean.
7. Using a needle-nose pliers, pull the injector straight out.
8. Flush water into the injector screen recess of the valve body to flush debris out through the injector recess.
9. Clean and flush the injector.
10. Lubricate the O-rings on the injector, injector cap, and injector screen with silicone lubricant (Autotrol® part number 1013501).
11. Reinstall the injector, injector cap, and injector screen. **Important:** Do not overtighten the plastic cap. Seat the cap lightly into position. Overtightening can cause breakage of the plastic cap, which may not be evident immediately.
12. Reinstall cover, reconnect electric power, and reset the time of day.
13. Slowly open the water supply valve or return the bypass valve(s) to the "not in bypass" position.

### Maintaining the Drain Line

The drain line discharges water and brine during the regeneration cycle. Typically, the line drains into your floor drain or laundry tub. The installer should plumb the drain line according to local codes, leaving an air gap between the end of the drain line and the drain opening, Figure 5.

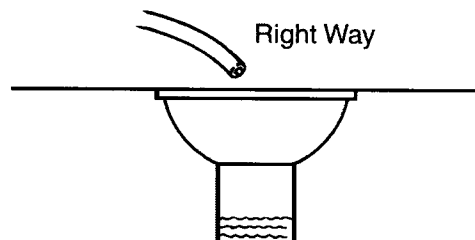

Figure 5



---

---

Be sure that the drain line remains unrestricted so that regeneration water and brine can flow freely to the drain. Do not set objects on the drain line that could crimp the line and restrict flow.

## Manual Valve Operation

The camshaft may be rotated manually to actuate the valve functions for service purposes.

1. Unplug the wall-mount transformer.
2. Remove the rear cover by pulling back on the tab provided on the cover. Next, lift the rear cover off the valve, Figure 2.
3. Rotate the camshaft COUNTERCLOCKWISE until the appropriate valve is opened by the camshaft lobe. Use the regeneration cycle indicator as a guide to which valve discs are open.
4. When the service is complete, rotate the camshaft so the regeneration cycle indicator is pointing to the end of the refill cycle.
5. Reinstall cover, reconnect electric power, and reset the time of day.
6. The display will show Err3 and the motor will start up. After approximately five minutes, the indicator will point to REGENERATION COMPLETE and the control starts alternating the display between TIME OF DAY and CAPACITY.
7. The conditioner is now in operation.

## Additional Features

When your dealer installs the conditioner, the control settings are adjusted to meet your soft water needs. However, there are additional features which your dealer can incorporate into the control. These features are 12- or 24-hour clock, U.S. or metric units of measure, Calendar Override and Immediate Regeneration.

### 12 or 24-Hour Clock

The standard clock is a 12-hour with a p.m. indicator. An optional 24-hour clock without a p.m. indicator is available. Time can be set from 00:00 to 23:59. This option applies to both the Time of Day and Time of Regeneration settings.

### U.S. or Metric Units of Measure

The standard units of measure are U.S. values. Hardness is in grains per gallon, salt is in pounds, and capacity is in kilograins. The metric option changes these to milligrams per liter, kilograins to kilograms respectively. All control settings use the metric values when the metric option is selected.

## Calendar Override

The Calendar Override option is a method of forcing the control to regenerate after a preset number of days, if a normal demand-based regeneration does not occur first. This feature is not set at the factory; your dealer can set it at one to 30 days.

## Immediate Regeneration

The control is factory set to wait until the Time of Day reaches the Time of Regeneration to begin a regeneration. Your dealer can program the control to regenerate any time the capacity remaining reaches zero. Remember that you do not have soft water available during any regeneration.

## Disinfection of Water Conditioners

The construction materials of the water conditioning system do not support bacterial growth or contaminate the water supply. However, we recommend that your conditioner be disinfected after installation and before the conditioner is used to treat potable water. In addition, a conditioner can become fouled with organic matter during normal usage or with bacteria from the water supply. Periodic disinfection is recommended for all conditioners.

Use one of the following methods of disinfection based on operating conditions, style of conditioner, type of ion exchanger, and disinfectant available.

### Sodium Hypochlorite

Sodium hypochlorite, 5.25% solutions, can be used with polystyrene resin, synthetic gel zeolite, greensand, and bentonites and are available under trade names such as Clorox, Linco, Bo Peep, White Sail, and Eagle Brand Bleach.

The recommended dosage for 5.25% solutions is:

- Polystyrene resin: 1.2 fluid ounces per cubic foot
- Non-resinous exchangers: 0.8 fluid ounce per cubic foot

### Calcium Hypochlorite

Calcium hypochlorite, 70% available chlorine, is available in several forms including tablets and granules. These solid materials can be used directly without dissolving before application. The recommended dosage for calcium hypochlorite is two grains (approximately 0.1 ounce) per cubic foot.

Complete the following steps to disinfect the conditioner:

1. Add the disinfectant to the brine well of the brine tank. Make sure that the brine tank has water in it so the solution is carried into the conditioner.
2. Press the REGEN button.

# Replacement Parts

## Valve Body and Tank Adapter Module

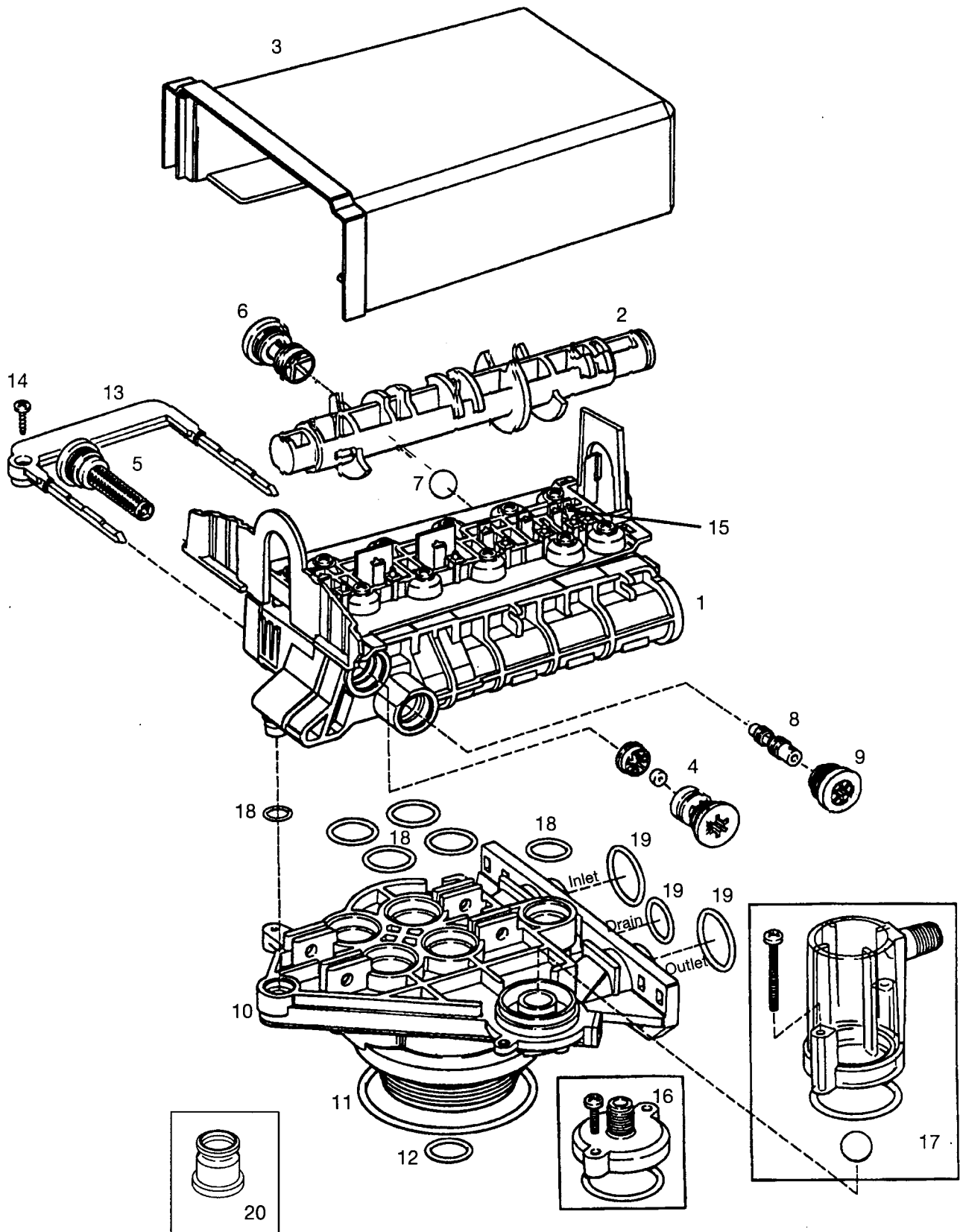

## Valve Body and Tank Adapter Module

Code	Part No.	Description	Qty.	Code	Part No.	Description	Qty.
1	1000238	Valve Assembly w/o Flow Controls	1	9		Injector Cap with O-Ring:	1
2	1000824	Camshaft, Standard, One-Piece	1		1000217	"A" Cap	
3	1000827	Valve Cover, Black	1		1000218	"B" Cap	
4		Brine Refill Flow Control Assembly:	1		1000219	"C" Cap	
	1000221	.14 gpm		10	1033784	Tank Adapter Assembly	1
	1000223	.40 gpm		11	1010429	O-Ring, 3-1/8 x 3-1/2 x 3/16 BN	1
5	1000226	Screen/Cap Assembly w/O-Ring	1	12	1010428	O-Ring, 3/4 x 1 x 1/8 EP	1
6		Drain Control Assembly w/O-Rings	1	13	1031402	Locking Bar: English Language	1
	1034162	No. 6 for 6-inch Diameter Tank		14	1006093	Screw, No. 8 x 9/16 inch	1
	1000209	No. 7 for 7-inch Diameter Tank		15	1001580	Spring, Valve Discs	9
	1000210	No. 8 for 8-inch Diameter Tank				Kits:	
	1000211	No. 9 for 9-inch Diameter Tank		16	1033066	New to Old Air Check Adapter	
	1000212	No. 10 for 10-inch Diameter Tank		17	1032416	Air Check Assembly	1
	1000213	No. 12 for 12-inch Diameter Tank		18	1001404	O-Ring Group: Tank Adapter	
	1000214	No. 13 for 13-inch Diameter Tank		19	1040459	O-Ring Group: Piping Boss	
	1000215	No. 14 for 14-inch Diameter Tank		20	1041010	13/16 Rubber Insert (Optional)	
7	1030502	Ball, Flow Control	1	*	1000250	Valve Discs Replacement	
8		Injector Assembly with O-Rings:	1				
	1032970	"A" Injector – White					
	1032971	"B" Injector – Blue					
	1032972	"C" Injector – Red					

\*Not Shown

# Meter Adapter, Bypass Valve and Piping Boss

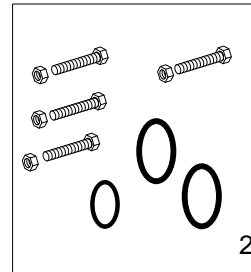
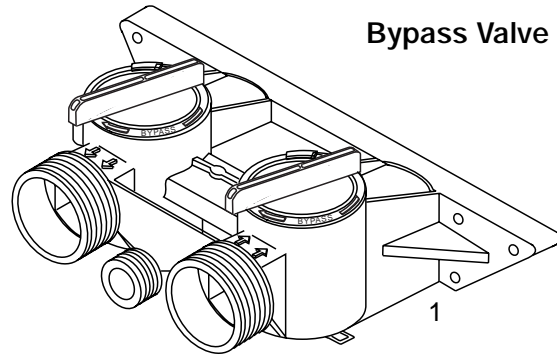

## Piping Boss

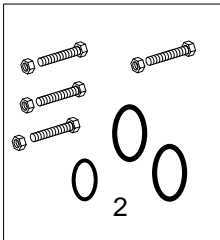
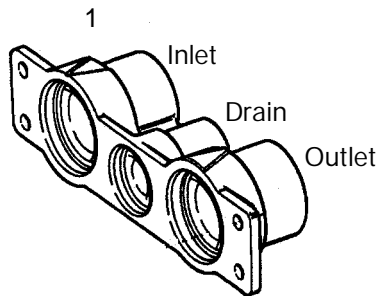

## 960 Control

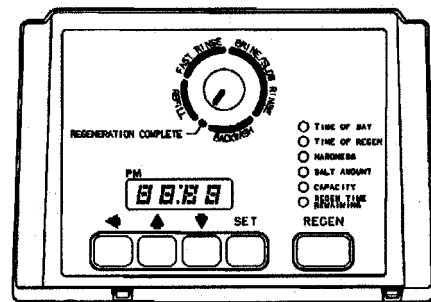

## Meter Adapter

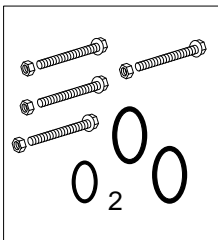
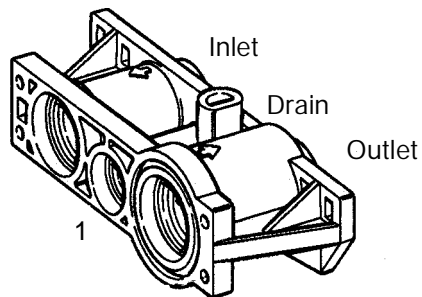

## Wall-Mount Transformer

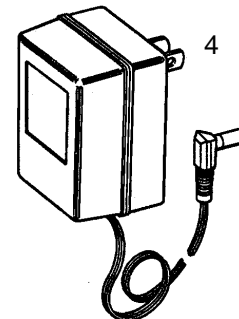

## Meter Adapter, Bypass Valve and Piping Boss

Code	Part No.	Description	Qty.	Code	Part No.	Description	Qty.
<b>Bypass Valve</b>				<b>Piping Boss</b>			
1	1040769	Bypass		1		Kit Piping Boss (includes hardware):	1
2	1040524	Installation Kit-Bypass	1	1040277		3/4-inch NPT, Brass	
				1040278		1-inch NPT, Brass	
*		Plumbing Adapters		1040281		3/4-inch BSPT, Brass	
1001606		3/4-inch Copper Tube Adapter Kit	1	1040282		1-inch BSPT, Brass	
1001670		1-inch Copper Tube Adapter Kit	1	1040279		3/4-inch NPT, Noryl	
1001608		22-mm Copper Tube Adapter Kit	1	1040280		1-inch NPT, Noryl	
1001609		28-mm Copper Tube Adapter Kit	1	1040283		3/4-inch BSPT, Noryl	
1001613		3/4-inch CPVC Tube Adapter Kit	1	1040284		1-inch BSPT, Noryl	
1001614		1-inch CPVC Tube Adapter Kit	1	2	1040339	Installation Kit-Piping Boss	
1001615		25-mm CPVC Tube Adapter Kit	1	*	1001408	Elbow Adapter	
				<b>Meter Adapter</b>			
1001769		3/4-inch NPT Plastic Pipe Adapter Kit	1	1	1032350	Kit, Meter Adapter	1
1001603		1-inch NPT Plastic Pipe Adapter Kit	1	2	1032351	Installation Kit-Meter Adapter	1
1001604		3/4-inch BSPT Plastic Pipe Adapter Kit	1				
1001605		1-inch BSPT Plastic Pipe Adapter Kit	1	3		960 or 960B Electronic Timer	1
1001611		3/4-inch BSPT Brass Pipe Adapter Kit	1	4		Wall-Mount Transformer	1
1001610		1-inch NPT Brass Pipe Adapter Kit	1		1000810	100V Japanese Plug	
1001612		1-inch BSPT Brass Pipe Adapter Kit	1		1000811	120V North American Plug	
					1000812	220V Australian Plug	
					1000813	220V British Plug	
					1000814	220V European Plug	

\*Not Shown

## Troubleshooting

Your water conditioning system is designed and manufactured for efficient, low maintenance service. However, if problems do occur, this section provides a list of possible causes and solutions.

Refer to Table 3 to help identify the cause of a problem. You can solve some problems yourself, such as low salt in the salt storage tank or a blown household fuse. However, some problems require installer or dealer assistance.

## Alarms

The control continuously monitors itself and sounds an alarm if it detects something wrong. The alarm is a beep that is on for one second and then off for nine

seconds. When the alarm sounds, the display shows the letters Err with a number from 1 to 4. Table 2 lists Err numbers, a description of each Err, the cause of the Err, and solutions. To silence the alarm, press any button on the control. If the error still exists, the control will go back to the alarm condition after 30 seconds.

**Important:** Service procedures that require the water pressure to be removed from the system are marked with a ! after the possible cause. To remove water pressure from the system, put the bypass valve or three-valve bypass into the bypass position and open the rinse drain valve (the fifth valve back from the control) with a screwdriver, Figure 3. Restore system water pressure when the service work is completed.

**Table 2**  
**Alarms**

Indication	Description	Cause	Solution
Err1	Electronics Failure.	Control settings need reprogramming.	Contact dealer.
Err2	Home switch closed when it should be open.	Faulty motor, circuit board or switch. Camshaft has been manually rotated during a regeneration.	Attempt a manual regeneration. If error persists, contact dealer.
Err3	Home switch open when it should be closed.	Faulty motor, circuit board, or switch. Camshaft has been manually rotated out of the "regeneration complete" position.	Contact dealer.  Control will turn the motor on and drive camshaft back to proper position.
Err4	Improper control settings.	One or more settings out of the allowable range.	Hardness: Adjust range: 3 to 250 grains/gallon (30 to 2500 mg/L) Capacity: Adjust range: 0.1 to 140.0 kilograins (0.1 to 14 kilograms) Others: Contact dealer.

**Table 3 Troubleshooting Procedures**

Problem	Cause	Solution
Hard Water at the Tap.	<ul style="list-style-type: none"> <li>a. Low or no salt in the salt storage tank.</li> <li>b. Salt setting too low to accommodate water hardness or water usage.</li> <li>c. Unit did not regenerate.</li> <li>d. Plugged injector !</li> <li>e. Air check valve prematurely closed.</li> </ul>	<ul style="list-style-type: none"> <li>a. Refill the salt storage tank and manually initiate a regeneration. Refer to the <b>Manual Regeneration</b> section in this manual.</li> <li>b. Change the salt setting. Refer to the <b>Salt Setting</b> section in this manual.</li> <li>c. Check power.</li> <li>d. Clean injector and screen. Refer to the <b>Cleaning the Injector/Injector Screen</b> in this manual. Briefly put control into brine refill status. Refer to the <b>Manual Valve Operation</b> section in this manual.</li> <li>e. Replace or repair air check if needed. Check brine line connections.</li> </ul>
Hard water leakage during service.	<ul style="list-style-type: none"> <li>a. Improper regeneration.</li> <li>b. Leaking of bypass valve !</li> <li>c. O-ring around riser tube damaged !</li> </ul>	<ul style="list-style-type: none"> <li>a. Check that the correct salt dosage is used. Repeat Regeneration.</li> <li>b. Contact dealer.</li> <li>c. Contact dealer.</li> </ul>
Loss of power to the system.	<ul style="list-style-type: none"> <li>a. Transformer unplugged.</li> <li>b. Fuse blown, circuit breaker open, or circuit switched off.</li> </ul>	<ul style="list-style-type: none"> <li>a. Connect power.</li> <li>b. Correct the electrical problem.</li> </ul>
Control does not regenerate automatically.	<ul style="list-style-type: none"> <li>a. Transformer unplugged.</li> <li>b. Defective control.</li> </ul>	<ul style="list-style-type: none"> <li>a. Plug transformer into outlet; plug transformer cable into control.</li> <li>b. Contact dealer.</li> </ul>
Control regenerates at the wrong time of day.	<ul style="list-style-type: none"> <li>a. Clock set incorrectly.</li> </ul>	<ul style="list-style-type: none"> <li>a. Reset clock. Refer to the <b>Time of Day clock/Time of Regeneration</b> sections in this manual.</li> </ul>
Control does not draw brine.	<ul style="list-style-type: none"> <li>a. Low water pressure.</li> <li>b. Restricted drain line.</li> <li>c. Injector or injector screen plugged !</li> <li>d. Injector defective !</li> <li>e. Valve disc 2 and/or 3 not closed.</li> <li>f. Air check prematurely closed.</li> </ul>	<ul style="list-style-type: none"> <li>a. Increase water pressure.</li> <li>b. Remove restriction.</li> <li>c. Clean injector and screen. Refer to the <b>Cleaning the Injector/Injector Screen</b> section in this manual.</li> <li>d. Replace injector. Contact dealer.</li> <li>e. Manually operate valve stem to flush out foreign matter holding disc open. Briefly put control into brine refill status. Refer to the <b>Manual Valve Operation</b> section in this manual.</li> <li>f. Replace or repair air check if needed. Check brine line connections.</li> </ul>

**Table 3 Troubleshooting Procedures**

Problem	Cause	Solution
Intermittent or irregular brine draw.	<ul style="list-style-type: none"> <li>a. Low water pressure.</li> <li>b. Defective injector !</li> </ul>	<ul style="list-style-type: none"> <li>a. Increase water pressure.</li> <li>b. Replace both injector and injector cap. Contact dealer.</li> </ul>
Brine tank overflow.	<ul style="list-style-type: none"> <li>a. Brine valve disc 1 held open.</li> <li>b. Valve disc 2 and/or 3 not closed during brine draw, causing brine refill.</li> <li>c. Air leak in brine line to air check.</li> <li>d. Salt setting too high.</li> </ul>	<ul style="list-style-type: none"> <li>a. Manually operate valve stem to flush out foreign matter holding disc open.</li> <li>b. Manually operate valve stem(s) to flush out foreign matter holding disc(s) open.</li> <li>c. Check all connections in brine line for leaks.</li> <li>d. See Table 1 for suggested salt settings.</li> </ul>
System using more or less salt than salt setting.	<ul style="list-style-type: none"> <li>a. Inaccurate setting.</li> </ul>	<ul style="list-style-type: none"> <li>a. Correct salt setting. Refer to the <b>Salt Setting</b> section in this manual.</li> </ul>
Control backwashes at excessively low or high rate.	<ul style="list-style-type: none"> <li>a. Incorrect backwash controller.</li> <li>b. Foreign matter affecting controller operation !</li> </ul>	<ul style="list-style-type: none"> <li>a. Contact dealer.</li> <li>b. Remove backwash controller. Clean and replace.</li> </ul>
Flowing or dripping water at drain line after regeneration.	<ul style="list-style-type: none"> <li>a. Drain valve (5 or 6) held open by foreign matter.</li> <li>b. Weak valve stem return spring.</li> </ul>	<ul style="list-style-type: none"> <li>a. Manually operate valve stem to flush out foreign matter holding disc open. Contact dealer.</li> <li>b. Contact dealer.</li> </ul>



---

---

## Specifications

Voltage.....	102 to 132 VAC, 60 Hz
Current.....	50 mA
Operating Temperature.....	.34 to 120°F (1 to 49°C)
Humidity.....	10 to 100% condensing allowed
Water Meter Accuracy.....	0.5 to 23 gpm (1.9 to 87 Lpm)

**Note:** Wall-mount transformer is rated for indoor use only.

## Glossary of Terms

### Alarms

Alarms are beeps which alert you to operating conditions requiring attention. The beeps are on for one second and off for nine seconds. The display shows the type of error. Refer to the **Alarms** section in this manual for additional information.

### Backwash

An upward flow of water which expands the resin bed to remove foreign particles.

### Brine

The salt solution which regenerates the conditioner's resin bed.

### Brine Draw

The process of drawing the brine solution from the salt storage tank into the resin tank.

### Calendar Override Regeneration

If a normal demand-based regeneration does not occur, the Model 960 Control regenerates the system after a preset number of days. Your dealer can set this feature at one to 30 days.

### Fast Rinse (Purge)

A flow of water through the resin bed which propels any remaining brine solution out of the resin tank to the drain.

### Hardness

A common quality of water containing dissolved calcium, magnesium and other elements. Water hardness is usually expressed in grains per gallon or milligrams per liter as calcium carbonate equivalent.

### Manual Regeneration (Guest Cycle)

Forces the control to regenerate by pressing the REGEN button.

### Regeneration

Includes the backwash, brine draw, and fresh water rinse steps necessary to prepare the resin bed for conditioning after exhaustion. Abbreviated as "REGEN" in this manual.

### Regeneration Indicator

The mechanical component which indicates the regeneration cycle status.

### Resin Bed

The supply of synthetic organic ion exchange material used in water conditioners.

