

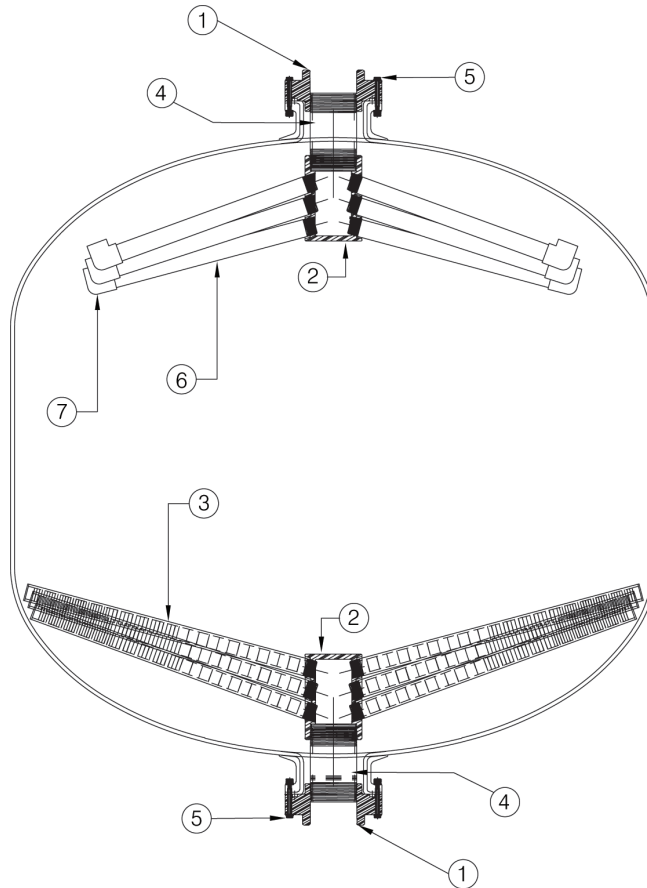





UNDERDRAIN ASSEMBLIES



WATER'S EDGE™ DISTRIBUTION SYSTEM KIT FOR 63 INCH COMPOSITE TANKS

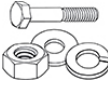

Pt	Part List	Qty	Description
1		2	Flange Adapter 6" SNA x 4" Socket PVC with EPDM Gasket 4" FNPT Inside Tank, 4" Socket Outside Tank with 12 Bolt Holes, 9-3/8" OD x 4" Height
2		2	Hub 4" FNPT, 21 each: 1" FNPT Type A Lateral Ports 3 Rows of 7 Lateral Ports at 15°, 18°, and 20° (Faced) 5-1/2" OD x 7-1/4" Height
3		21	Lateral S80 1" MPT x 28" OAL 0.010 Slot CUSTOM 1.315" OD x 28" OAL
4		2	Nipple 4" MPT x 7", 0.010" Slots 5 Rows x 2 Slots on Each End 4-1/2" x 7" OAL
5		1	Hardware Kit SS304 for 6" SNA Flange Adapter 24 each: Washers; 12 each: Lock Washers; 12 each: Nuts; 12 each: Bolts
6		21	Nipple 1" NPT x 12" Machine Threaded Both Ends (TBE)
7		21	Elbow 90° 1" FNPT x Socket 2.4" Length x 2.25" Width x 1.625" OD